

MVP12, 6XM12, 5POLE, M23 19POL. CON.

Connector exit frontside

6-way, 5-pole

M23 plug connection

19-pole used

with LED for digital PNP-signals 24 V DC

Plastic housings with good resistance against chemicals and oils.

The resistance to aggressive media should be individually tested for your application. Further details on request.

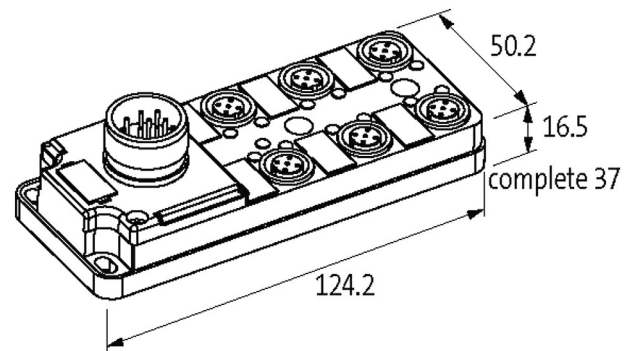
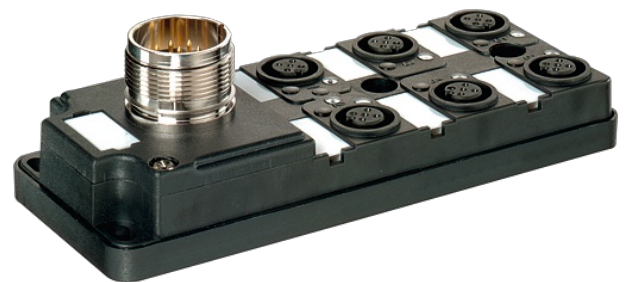
[Link to Product](#)**Illustration**

M12-Females 5-pole

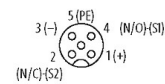

M23-Plug 19-pole

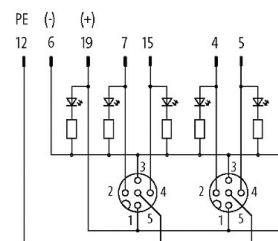
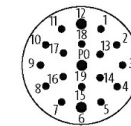

for 2 signals per port

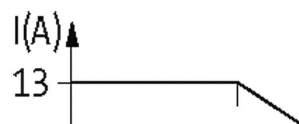

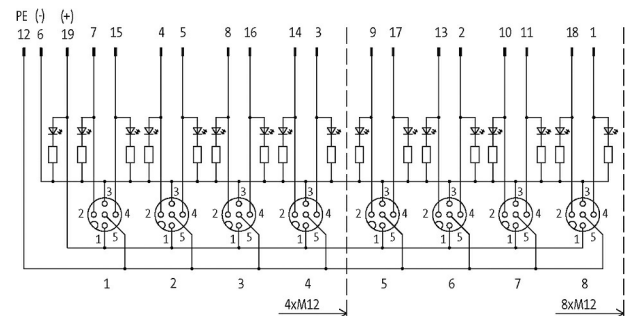
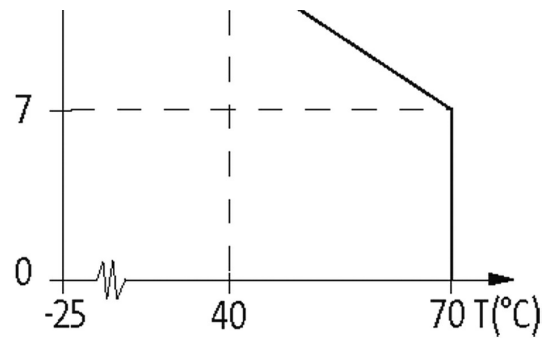

Product may differ from Image

Approvals



Technical Data

Operating voltage	24 V DC
Signal per port	2
Operating current per contact	max. 4 A
Total current	max. 10 A
Housing	Plastic, flame retardant
Protection	IP67 inserted and tightened (EN 60529)
Locking of ports	Screw thread (M12×1 mm)

General data

Temperature range	-20...+80 °C
Dimensions H×W×D	99.2×50.2×16.5 mm

Contact Layout

PIN 1	(+)
PIN 2	(NC)/(S2)
PIN 3	(-)
PIN 4	(NO)/(S1)
PIN 5	(Earth)
	LED (green): Power / LED (yellow): (S1/S2)

Commercial data

country of origin	DE
customs tariff number	85369010
EAN	4048879063203

eClass	27279219
Packaging unit	1
