

MQ15 female 0° with cable 48V DC type 2

PUR 6x2.5 bk UL/CSA+drag ch. 1m

Female straight

MQ15, 6-pole

with cable sleeves

Plastic housings with good resistance against chemicals and oils.

The resistance to aggressive media should be individually tested for your application. Further details on request.

Further cable lengths on request.

[Link to Product](#)

Illustration

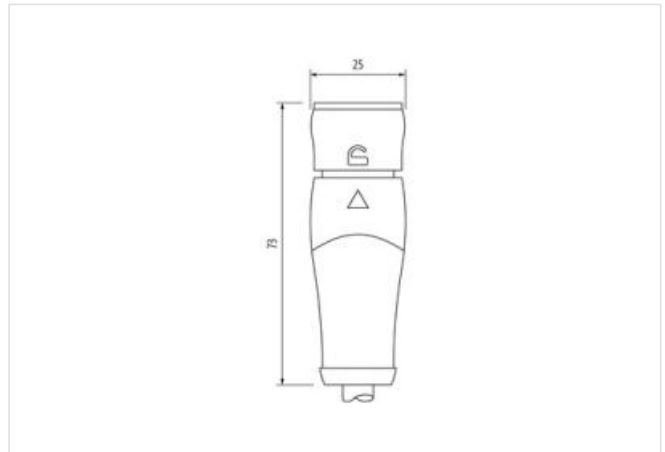
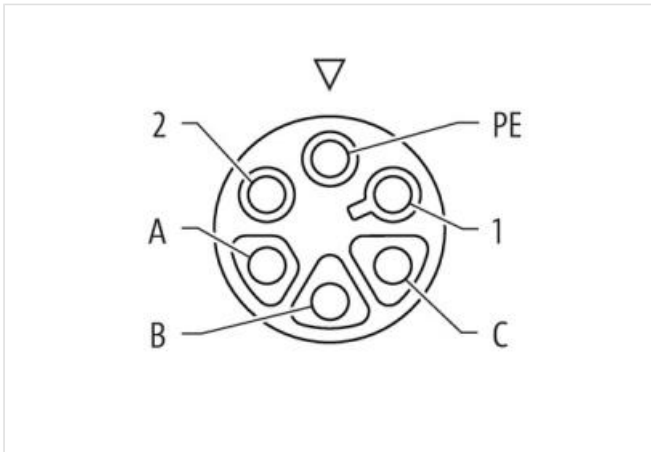

Product may differ from Image



Cable length 1 m

Side 1

Mounting method inserted, locked

Coating contact	silver-plated
Family construction form	MQ15
suitable for corrugated tube (internal Ø)	18 mm
Cable outlet	straight
Coding	Type 2
Material contact	Copper alloy
No. of poles	6
Degree of protection (EN IEC 60529)	IP65, IP67

Side 2

Stripping length (jacket)	100 mm
---------------------------	--------

Commercial data

ECLASS-6.0	27279218
ECLASS-6.1	27279218
ECLASS-7.0	27279218
ECLASS-8.0	27279218
ECLASS-9.0	27060327
ECLASS-10.1	27060311
ECLASS-11.1	27060311
ECLASS-12.0	27060327
ETIM-5.0	EC001855
customs tariff number	85444290
GTIN	4065909060551
Packaging unit	1

Electrical data | Supply

Operating voltage DC	48 V
Operating current per power contact max.	20 A
Operating current per signal contact max.	4 A

Diagnostics

Status indication LED	no
-----------------------	----

Installation | Connection

Stripping length (jacket)	100 mm
---------------------------	--------

Installation | Pin assignment

Coding	Type 2
Configuration	fully used

Device protection | Electrical

Additional condition protection degree	inserted, locked
Pollution Degree	3
Rated surge voltage	0,8 kV
Material group (IEC 60664-1)	I

Mechanical data | Material data

Material housing	PUR
Material contact carrier	PA
Locking material	POM

Mechanical data | Mounting data

Looking techniques	bayonet-locking
--------------------	-----------------

Environmental characteristics | Climatic

Operating temperature min.	-30 °C
Operating temperature max.	85 °C
Additional condition temperature range	depending on cable quality

Important installation notes

Note on strain relief	Protect the connectors by suitable measures from mechanical loads, e.g. by the usage of cable ties.
Note on bending radius	Attention: Observe the permissible bending radii when laying cables, as the IP protection class can be endangered by excessive bending forces.

Conformity

Product standard	IEC 61076-2-116
------------------	-----------------

Installation | Cable

wire arrangement	black 5, black 4, black 3, black 2, black 1, green-yellow
Cable identification	P63
Cable Type	3
Jacket Color	black
Type of Certificate	cURus
Stranding	6 wires around Filler twisted
Filler	yes
wire arrangement	black 5, black 4, black 3, black 2, black 1, green-yellow
Cable weight	227,7 g/m
Material jacket	PUR
Shore hardness jacket	90 ± 5 Shore A
Freedom from ingredients (jacket)	lead-free, cadmium-free, CFC-free, halogen-free, silicone-free
Outer-diameter (jacket)	10,5 mm
Tolerance outer diameter (sheath)	± 5 %
Material wire insulation	PP
Amount wires	6
Outer diameter insulation	2,85 mm
Outer diameter tolerance core insulation	± 5 %
Ingredient freeness wire insulation	lead-free, cadmium-free, CFC-free, halogen-free, silicone-free
Amount strands (wire)	140
Diameter of single wires	0,15 mm
Conductor crosssection (wire)	2,5 mm ²
Material conductor wire	Stranded copper wire, bare
Conductor type (wire)	strand class 6
Shore hardness wire insulation (Data)	60 ± 5 Shore D
Nominal voltage AC max.	1000 V
Current load capacity (standard)	to DIN VDE 0298-4
Current load capacity min. wire	19,5 A
Electrical resistance line constant wire	8 Ω/km @ 20 °C
AC withstand voltage (wire - wire)	10 kV
Power frequency withstand voltage (wire - jacket)	10 kV
Min. operating temperature (static)	-50 °C
Max. operating temperature (fixed)	80 °C / 90 °C @ 10000 h Operation
Operating temperature min. (dynamic)	-25 °C
Operating temperature max. (dynamic)	80 °C / 90 °C @ 10000 h Operation
UV resistance	DIN EN ISO 4892-2 A
Flame resistance	UL 1581 § 1090 IEC 60332-2-2 UL 1581 § 1100 FT2
chemical resistance	Good, application-related testing
Gasoline resistance	Good, application-related testing
Oil resistance	DIN EN 60811-404 Good, application-related testing
Bending radius (fixed)	5 x Outer diameter
Bending radius (dynamic)	10 x Outer diameter
No. of bending cycles (C-track)	5 Mio. @ 25 °C
Traversing distance (C-track)	5 m @ 25 °C
Travel speed (C-track)	3,3 m/s @ 25 °C
No. of torsion cycles	2 Mio. 25 °C
Torsion stress	± 180 °/m @ 25 °C

The information in this Product-PDF has been compiled with the utmost care.

Liability for the correctness completeness and topicality of the information is restricted to gross negligence. Version: 2024-06-25

Torsion speed

35 cycles/min 25 °C