

M12 male 0° D-cod. with cable shielded

PVC 1x4xAWG22 shielded gn UL/CSA+drag ch. 30m

Ethernet CAT5

Transmission properties with channel transmission up to 100 m

Male straight

M12, 4-pole

D-coded

shielded

Further cable lengths on request.

Plastic housings with good resistance against chemicals and oils.

The resistance to aggressive media should be individually tested for your application. Further details on request.

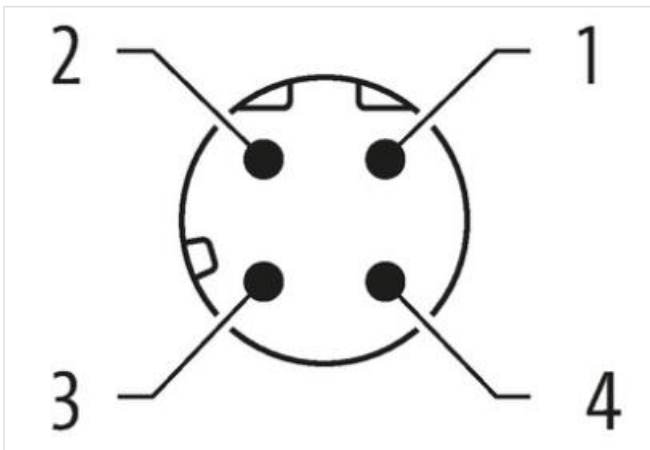
[Link to Product](#)**Illustration**

Product may differ from Image

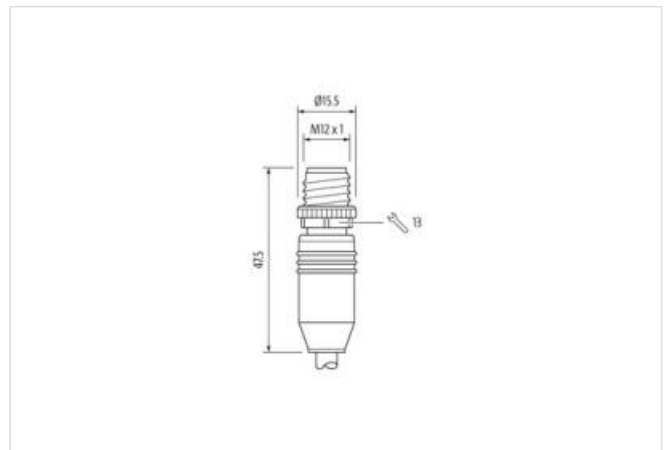



Cable length	30 m
Side 1	
Tightening torque	0,6 Nm
Mounting method	inserted, screwed
Family construction form	M12
Thread	M12 x 1
Cable outlet	straight
Coding	D
Material	PUR
No. of poles	4
Width across flats	SW13
Degree of protection (EN IEC 60529)	IP65, IP66K, IP67

Side 2	
Stripping length (jacket)	20 mm
Family construction form	free cable end

Commercial data	
ECLASS-6.0	27061801
ECLASS-6.1	27060307
ECLASS-7.0	27060307
ECLASS-8.0	27060307
ECLASS-9.0	27060307
ECLASS-10.1	27060307
ECLASS-11.1	27060307
ECLASS-12.0	27060307
ETIM-5.0	EC002599
customs tariff number	85444290
GTIN	4065909006580
Packaging unit	1

Electrical data Supply	
Operating voltage DC max.	60 V
Current operating per contact max.	1,5 A

Industrial communication	
Transfer parameters	CAT5, Class D (ISO/IEC 11801:2002), (EN 50173-1)
Data transmission rate max.	100 MBit/s

Industrial communication Ethernet functionality	
duplex	Full duplex

Diagnostics	
Status indication LED	no

Installation Connection	
Stripping length (jacket)	20 mm
Mounting set	M12 x 1

Device protection Electrical	
Additional condition protection degree	inserted, screwed
Pollution Degree	3
Rated surge voltage	1,5 kV
Material group (IEC 60664-1)	I
Mechanical data	
Contour for corrugated hose	without
Mechanical data Material data	
Coating locking	Nickeled
Coating of fitting	nickel plated
Locking material	Zinc die-casting
Material screw connection	Zinc die-casting
Mechanical data Mounting data	
Mounting method	inserted, screwed, Shaking protection
Environmental characteristics Climatic	
Operating temperature min.	-25 °C
Operating temperature max.	85 °C
Additional condition temperature range	depending on cable quality
Important installation notes	
Note on strain relief	Protect the connectors by suitable measures from mechanical loads, e.g. by the usage of cable ties.
Note on bending radius	Attention: Observe the permissible bending radii when laying cables, as the IP protection class can be endangered by excessive bending forces.
Conformity	
Product standard	DIN EN 61076-2-101 (M12)
Installation Cable	
wire arrangement	yellow, blue, orange, white
Cable identification	800
Jacket Color	green
Type of Certificate	cURus
Amount stranding	1
Stranding	4 wires around Filler star-shaped twisted
Cable shielding (type)	copper braid, tinned
Cable shielding (coverage)	85 %
Banding	Foil
Filler	yes
wire arrangement	yellow, blue, orange, white
Cable weight	73,7 g/m
Material jacket	PVC
Shore hardness jacket	85 ± 5 Shore A
Freedom from ingredients (jacket)	lead-free, CFC-free
Outer-diameter (jacket)	6,6 mm
Tolerance outer diameter (sheath)	± 5 %
Material inner jacket	FRNC
Color (inner jacket)	natur
Material wire insulation	PE
Amount wires	4
Outer diameter insulation	1,53 mm
Outer diameter tolerance core insulation	± 5 %
Shore hardness wire insulation	55 ± 5 Shore D
Ingredient freeness wire insulation	lead-free, CFC-free, halogen-free
Amount strands (wire)	7

Diameter of single wires	22 AWG
Conductor crosssection (wire)	22 AWG
Material conductor wire	Stranded copper wire, bare
Nominal voltage AC max.	300 V
Current load capacity (standard)	to DIN VDE 0298-4
Current load capacity min. wire	4,8 A
Characteristic impedance	100 Ω \pm 15 % @ 1 MHz
Electrical resistance line constant wire	55 Ω /km @ 20 °C
AC withstand voltage (wire - wire)	2 kV @ 60 s
Electrical capacity line constant (wire - wire)	50000 pF/km
Power frequency withstand voltage (wire - jacket)	2 kV @ 60 s
AC withstand voltage (wire - shield)	2 kV @ 60 s
Min. operating temperature (static)	-30 °C
Max. operating temperature (fixed)	80 °C
Operating temperature min. (dynamic)	-10 °C
Operating temperature max. (dynamic)	70 °C
Flame resistance	UL 1581 § 1090 UL 1581 § 1100 FT2 IEC 60332-2-2
chemical resistance	Good, application-related testing
Gasoline resistance	Good, application-related testing
Oil resistance	Good, application-related testing DIN EN 60811-404
Bending radius (fixed)	5 x Outer diameter
Bending radius (dynamic)	15 x Outer diameter
No. of bending cycles (C-track)	2 Mio. @ 25 °C
Traversing distance (C-track)	5 m @ 25 °C
Travel speed (C-track)	3,3 m/s @ 25 °C